







gala

Referencia G3990500
Descripción Monomando de bidé
Serie CLUNIA



CARACTERÍSTICAS TÉCNICAS

-  Incorpora limitador de caudal a 5 l/min
 -  Certificación AENOR
 -  Fabricado utilizando materiales reciclados
 -  Fabricado con aleaciones incluidas en la "European Positive List" (para la no migración de materiales peligrosos al agua)
 -  Bajo nivel de ruido
 -  Tecnología de cromado G-Last: alta resistencia al rayado
- Cartucho de discos cerámicos de $\varnothing 35$ mm
- Incluye enlaces de alimentación flexible de 3/8"
- Instalación con válvula up-down

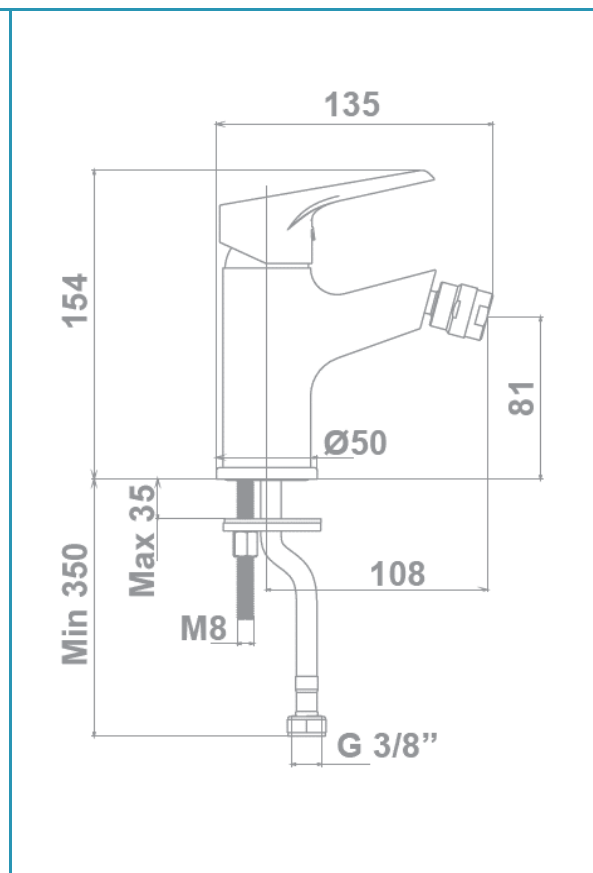

CURVA DE CAUDALES

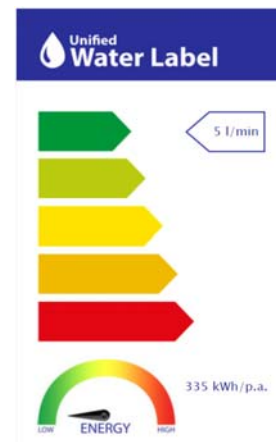
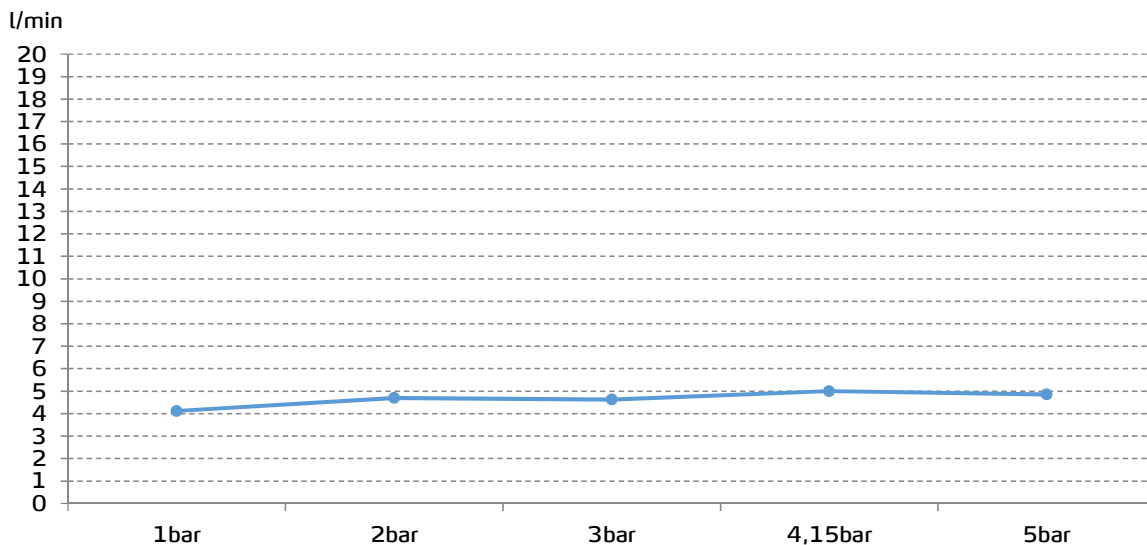

Datos medidos en posición de mezcla y máxima apertura